



1008315020

TCIV-2+

IP and SIP Video Intercom

- ✓ Powerful audio technology, including high sound pressure, automatic volume gain control, and noise and acoustic echo cancellation.
- ✓ HD video up to 1080p resolution
- ✓ Wide angle lens
- ✓ High performance hardware platform with 4 x Cortex-A53 CPU cores and 512MB LPDDR4 RAM
- ✓ ONVIF Conformant
- ✓ Vandal Resistant Design
- ✓ IP66 - Dirt, dust and water resistant
- ✓ Cybersecurity compliant
- ✓ Can operate in SIP, IC-EDGE and ICX-AlphaCom mode

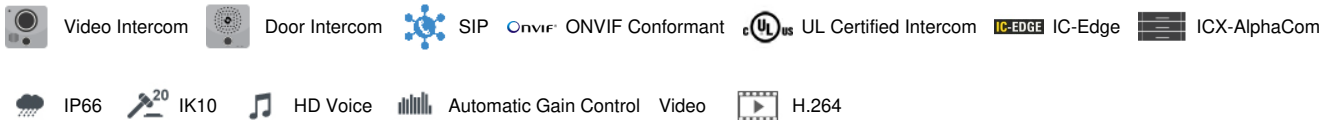

Description

The TCIV-2+ station utilize the latest technology to create unparalleled audio quality.

Some of the many features include: HD voice quality, Open Duplex, noise and acoustic echo cancellation, MEMS microphone, a 10W Class D amplifier and our unique speaker grille design. These features, in conjunction with the company's 70+ years of experience with acoustic technology, are just a few of the many factors that contribute to our superior audio quality.

The Turbine IP Video Intercom range expands this feature set with wide FoV HD Video, Digital PTZ and support for H.264 and MJPEG.

For additional information about TCIV-2+, please see [Zenitel Wiki](#).

Technical Dimensions

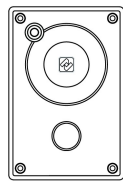
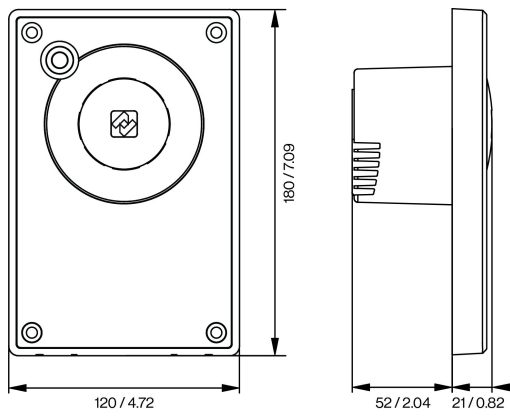

TCIV-2+
TCIV-3+

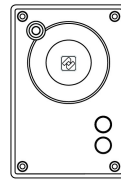

TCIV-5+

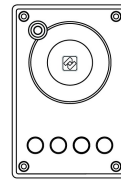

TCIV-6+

All dimensions are in mm / in

Specifications

AUDIO

SPL peak power at 1m in open duplex	90 dB
SPL peak power at 1m in half duplex	100 dB
SPL peak power at 1m in program distribution and announcement	100 dB
Noise cancelling	Yes
Codecs	G.711, G.722, G.729
Frequency range, G.722 Codec	200 Hz – 7000 Hz
Audio technology	Modes: Full open duplex, switched open duplex
	Adaptive jitter buffer
	Custom Ringing Tone
	Audio Mixing – Conversation and Group Call
	Automatic gain control (microphone)
	Sound Level Detection / scream alarm (in AlphaCom mode)
Internal speaker amplifier	10 W class D
Internal speaker	10 W
Microphone technology	Digital MEMS, omnidirectional microphone
Automatic Volume Control (AVC)	Yes
Acoustic Echo Cancellation (AEC)	Yes

VIDEO

Lens	F 2.0, fixed iris
Image Sensor	1/2.5" RGB CMOS
Light Sensitivity	Down to 1 lux
Resolution	240 / 480p / 960x720p / 1440x1080p*
Frame Rate	Up to 30 FPS in 1440x1080p**
Supported Codecs	MJPEG, H.264 **
Digital PTZ	Yes
Digital Zoom	Up to 2x
Field of View	Configurable up to 180 degrees horizontally and vertically
Parallel videostreams	6 (1x SIP H.264, 2x HTTP MJPEG, 3x RTSP sessions)
	* MJPEG does not support 720p and 1080p resolution.
	** 30 FPS is only supported in H.264 mode, while MJPEG is limited to 10 FPS.
	*** AlphaCom mode supports only RTSP H.264 mode, while other modes support SIP H.264.

HARDWARE

Ethernet connector	1 x RJ-45
All other connectors	Tool less, spring loaded, vibration proof terminals
General inputs and outputs	6 (configurable)
Outputs	12mA as LED drivers
Change-over relay (NO+NC+COM)	SELV
Power options	PoE, PoE+
PoE (Power over Ethernet)	IEEE 802.3af standard, IEEE 802.3at
Power consumption	Idle 3.5W, max 12W (depending on volume)
Audio Line out / Induction loop signal	0 dBV
Button backlight	LED
Call indication	Icons/colors for hearing impaired

PROCESSOR/CHIPSET

CPU cores	4 x Cortex-A53
CPU Clock Speed	1.6 GHz
RAM	512 MB LPDDR4
Flash	1 GB
Video encoder	MJPEG, H.264
Dual Image	Yes

CONSTRUCTION

Dimensions (HxWxD)	180 x 120 x 73 mm / 7.1" x 4.7" x 2.9"
Dimensions after flush mount	180 x 120 x 24 mm / 7.1" x 4.7" x 0.9"
Dimensions with on wall box	180 x 120 x 86 mm / 7.1" x 4.7" x 3.4"
Weight	1 kg / 2.2 lbs.
Faceplate material	3 mm / 0.12" stainless steel - AISI 316L
Base / frame material	3 mm / 0.12" Aluminum alloy - A413.0, AlSi12Fe, painted
Electronics cover material	Polycarbonate (semi translucent)
Gasket material	TPV
Fastening bracket material	SECC Steel
Button material	3 mm / 0.12" Polycarbonate (transparent)
Button travel length	1.25 mm
Button activation force	350 gf
Button push-cycles before failure	300 000
Loudspeaker poke protection, large diameter object	3D cast aluminum speaker grille
Loudspeaker poke protection, small diameter objects	Stainless steel mesh, acoustically transparent
Anechoic Design	Open flow anechoic design eliminates "standing waves"

NETWORKING & PROTOCOLS

Protocols	IPv4 (with DiffServ), SIP, TCP, UDP, HTTPS, TFTP, RTP, RTSP, RTCP, SRTP, DHCP, SNMP, Vingtor-Stentofon CCoIP®, NTP, ONVIF, WS-Discovery
LAN protocols	Power over Ethernet (IEEE 802.3 a-f), Power over Ethernet (IEEE 802.3at), Network Access Control (IEEE 802.1x)
Management and operation	HTTP/HTTPS (Web configuration) DHCP and static IP. Remote automatic software upgrade. Centralized monitoring.
Advanced supervision functions	E.g. network test, tone test, status reports
SIP support	RFC 3261 (SIP base standard) RFC 3515 (SIP refer) RFC 2976 (SIP info), SIP using TLS, RFC 5630 SIPS URI scheme
DTMF support	RFC 2833, 2976 (SIP info)
Integration and API	AlphaCom, Scripting (plugins)

ENVIRONMENTAL

IP rating	IP-66, tested according to EN 60529 (applies when mounted in TA-1 back-box)
Operating temperature range	-40° to 70° C / -40° to 158 ° F
Storage temperature range	-40° to 70° C / -40° to 158 ° F
Relative humidity	< 95% not condensing
UV-resistant	Yes
EMC	CE and FCC Part 15

CERTIFICATIONS

ONVIF Conformant	Profile S
------------------	-----------

OTHER SPECIFICATIONS

IP address information	Speaks IP address after system boot
Country of manufacture	Poland
Warranty	2 Years standard warranty, extendible up to total of 5 years (additional fee)

Accessories



TA-1

Turbine Compact Onwall Back Box



TA-2

US 2-Gang 3 1/2" Deep Backbox



TA-5

Bracket for US 2 GANG Double Depth Back Box



TA-18

Turbine Compact Flush-Mount Back Box



TA-14

Microphone windshield for TCIS / TCIV



Touchless Sensor

Used With



ITSV-4

HD IP Video Phone with 5" Screen



ITSV-5

HD IP Video Phone with 8" Screen